

ORBINOX

VALVE SOLUTIONS IN MORE THAN 70 COUNTRIES

Valves for
mining

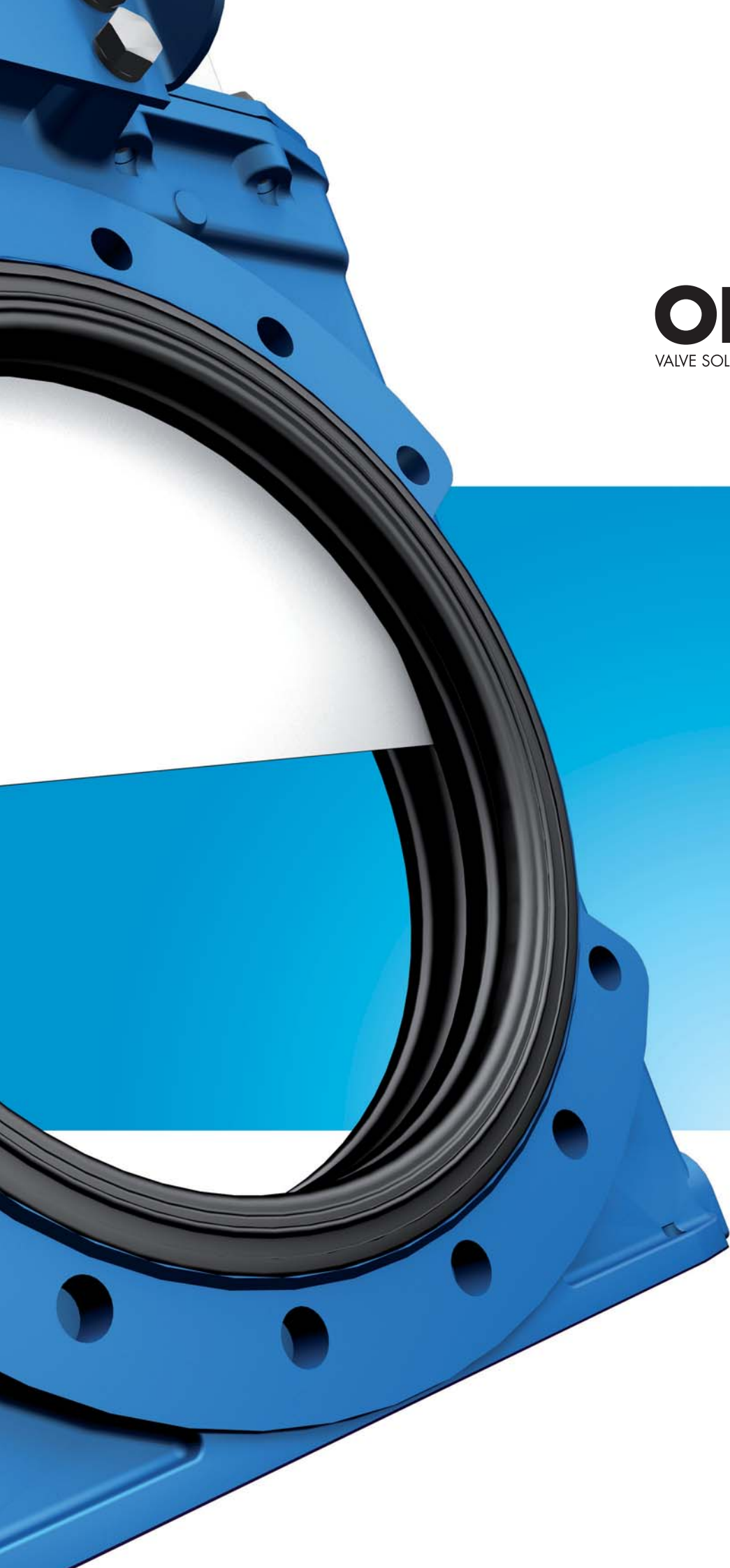

MORE THAN 50 YEARS

ORBINOX is present in more than 70 countries with over 50 years of experience designing, manufacturing and marketing knife gate valves, penstocks, dampers, and valves for hydraulic works.

We are today a global leader in the manufacturing of knife gate valves.

Product quality and customer satisfaction are our goals. We have a highly qualified and experienced team providing the best solutions to suit the needs of our customers. Our production plants are equipped with the most up to date machinery which combined with our modular product design and production-to-order system, allows us to be highly flexible with specifications and delivery times.



WIDE PRODUCT RANGE

We offer a wide range of knife gate valves, penstocks, dampers and valves for hydraulic works which cover a large variety of applications in various business segments such as Water & Waste Water Treatment, Mining, Power Generation, Pulp & Paper, Food & Beverage, Bulk Handling, Steel Industry, Air Separation and Dams, Reservoirs and Hydro Solutions.

Product innovation and product quality are key values for ORBINOX, allowing us to adapt to increasingly faster market changes and to maintain our leadership.



LEADING MANUFACTURER OF KNIFE GATE VALVES



6 manufacturing plants
and 12 sales companies

With 6 Manufacturing Plants in Europe, the Americas and Asia, 12 Sales Companies and an extensive network of Distributors worldwide, ORBINOX is currently present in over 70 countries across the five continents, enabling us to be close to our customers in order to offer technical advice and respond to their requirements.

We think globally, whilst applying local expertise.

ORBINOX IN MINING



Mining is one of the main industrial segments for ORBINOX. As a result of our long experience in knife gate valve design and manufacturing for mining applications, ORBINOX offers today a comprehensive range of slurry knife gate valves.

Our goal at all times is to offer excellent performance and low maintenance downtime solutions that solve our Customers' most demanding application needs.

Our experience in the design and manufacturing of special valves allows us also to adapt to special application requirements. ORBINOX has the capacity to customize solutions by offering the appropriate valve for every application.

MINING APPLICATIONS

Abrasion, erosion and corrosion are the main challenges of slurry applications. Fluid handling equipment must be specifically designed and manufactured to operate under these conditions.

CONCENTRATION PLANTS

After crushing, the ore is conveyed to the concentration plant.

When further reducing the particle size in the comminution area (crushers, high pressure grinding rolls, autogenous and semi-autogenous mills, ball mills, etc.), the produced slurries are usually of high solid concentration and large particle size. Our rugged heavy duty WG valve has been specifically designed to operate in these severe conditions.

In the cyclones, where the mineral ore is first separated based on size, the WG valve provides an exceptional performance due to particle size and concentration. The lighter construction and more economical VG valve is also an excellent solution depending on the mineral type, concentration and size.

In the separation process based on particle type (usually flotation cells, also gravity separation or magnetic separation) where the particle size is small, our VG valve has an excellent performance.

The concentrated mineral ore is then dewatered in the thickeners. Both, VG and WG valves are, depending on each mine's process, perfect solutions for these units.

Finally, the mineral goes through filtering (usually vacuum or press filters). VG, WG valves offer efficient performance.

Tailings: different valves can be used in the handling of tailings or the left-over materials separated from the mineral ore. Depending on the process pressure, VG, WG and HG valves can be used.



LEACHING PLANTS

After crushing and, in many cases, also milling as in the concentration plants, copper, gold, silver and many other metal ores are processed in leaching plants.

Our VG and WG valves are well suited for tank leaching processes, both in the same leaching process in tanks and vats as well as in the subsequent thickening and filtering stages. The valves are specifically designed to operate in corrosive environments to provide extended valve life.

Our VG and WG valves are also a good solution for certain areas in pressure leaching or in high pressure and temperature leaching in autoclaves.

OTHER APPLICATIONS

Slurry pipelines: the HG valve has been designed to operate with slurries at high pressure. Its heavy-duty construction allows to handle either tailing slurries or mineral ore concentrate slurries.

Process water: mines require large quantities of water for many different uses. Our product range for water treatment, such as the EX, ET and BT knife gate valves and the MU, CC, RB, SL/SA penstocks offer excellent solutions for mining water applications.

ORBINOX Slurry Knife Gate Valves have been engineered considering these specific mining operational conditions to guarantee an optimum performance.

ORBINOX SLURRY KNIFE GATE VALVES

VG
Wafer Style



WG
Heavy Duty



HG
Heavy Duty
High Pressure



- Size range
VG DN 50 mm to DN 900 mm
WG DN 80 mm to DN 900 mm
HG DN 80 mm to DN 600 mm
- Cold working pressure of 10 bar for VG and WG and 20 bar for HG
- Wafer style body for VG and heavy duty wide face-to-face body for WG and HG

- Bi-directional 100% bubble-tight shut off
- Full port design for greater flow capacity and minimal pressure drop
- No cavities where solids can collect and prevent the gate from closing
- No metallic parts in contact with the slurry
- Manual, pneumatic, electric and hydraulic actuators available

OTHER VALVES

EX/ET/BT
Knife Gate Valves

- Wafer or lug type (MSS SP-81)
- Uni- or bi-directional
- Size range: DN 50 mm to DN 900 mm (EX, DN 2100 mm)
- Rising and non-rising stem available
- Wide range of materials available
- Resilient seated and metal-to-metal
- Epoxy-coating on all cast iron/carbon steel components
- Manual, pneumatic, electric and hydraulic actuators
- Bonnets, flush ports, V-ports, special materials, fabricated valves



MU/CC/RB/SL/SA
Penstocks

- Meet or exceed DIN 19569-4
- Four-side (wall-mounted) and three-side (channel gate) sealing
- Uni- or bi-directional
- Sizes up to 4000 mm x 4000 mm
- Fabricated stainless steel construction. Wide range of materials available
- Self-adjusting sealing and self-cleaning HMWPE guides
- Rising stem and non-rising stem for gates
- Manual, pneumatic, electric and hydraulic actuators



ORBINOX SLURRY KNIFE GATE VALVES

VG Wafer Style

- Single cast or fabricated monoblock design
- Wafer style body
- Open bottom for body cleaning
- Nodular cast iron body as standard, other materials available
- Flushing ports available for body cleaning
- Rectangular shape stainless steel gate, polished both sides and with the bottom end machined to an edge. Other materials and gate coatings available
- Patented bidirectional double elastomer sleeve design with internal steel ring

Material	Max.Temp	Applications
Natural rubber	80 °C	General
EPDM	120 °C	Acids and non-mineral oils
CR (Neoprene)	90 °C	Oils and solvents
NBR (Nitrile)	100 °C	Hydrocarbons, oils and greases
FKM (Viton)	200 °C	High temperature

- In the open position, sleeves are compressed against each other. In the closed position, the gate is between the sleeves. Both cases are 100% tight shut-off

BI-DIRECTIONAL DOUBLE SLEEVE DESIGN

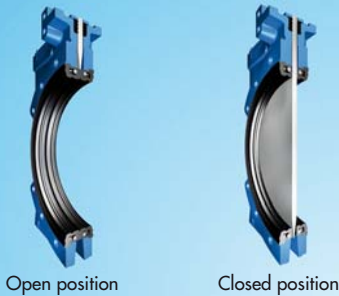

Open position

Closed position

- Maintenance free EPDM gland packing. PTFE compression packing plus O-ring available
- Stainless steel stem
- Reinforced yoke design in large sizes
- Optional gate lockout system available
- Epoxy coating on all cast iron and carbon steel components
- Extensions and floor stands
- Automated valves with gate guards in accordance with safety standards
- Wide variety of accessories available: limit & proximity switches, mechanical stops, solenoid valves, manual overrides and fail safe systems
- Splash guards, flat plate and tubular design available



Flat Plate

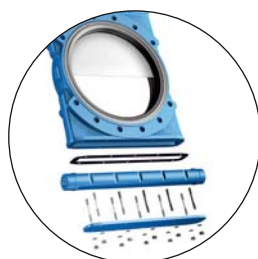

Tubular Design

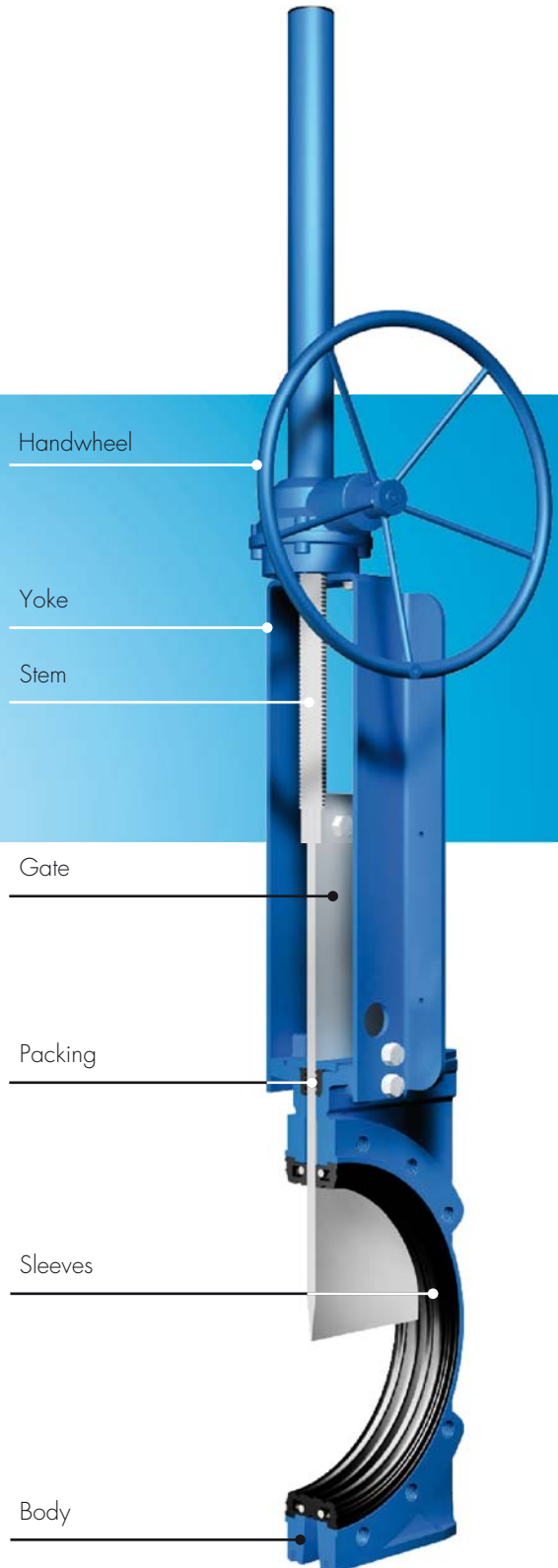

WG Heavy Duty & HG High Pressure

- Single cast or fabricated monoblock design
- Flanged body
- Open bottom for body cleaning
- Nodular cast iron body as standard, other materials available
- Flushing ports available for body cleaning
- Rectangular shape stainless steel gate, polished both sides and with the bottom end machined to an edge. Other materials and gate coatings available
- Heavy duty bi-directional double elastomer sleeve design with internal steel ring
- Availability of same range of sleeve materials as for VG
- In the open position, sleeves are compressed against each other.
- In the closed position, the gate is between the sleeves. Both cases are 100% tight shut-off

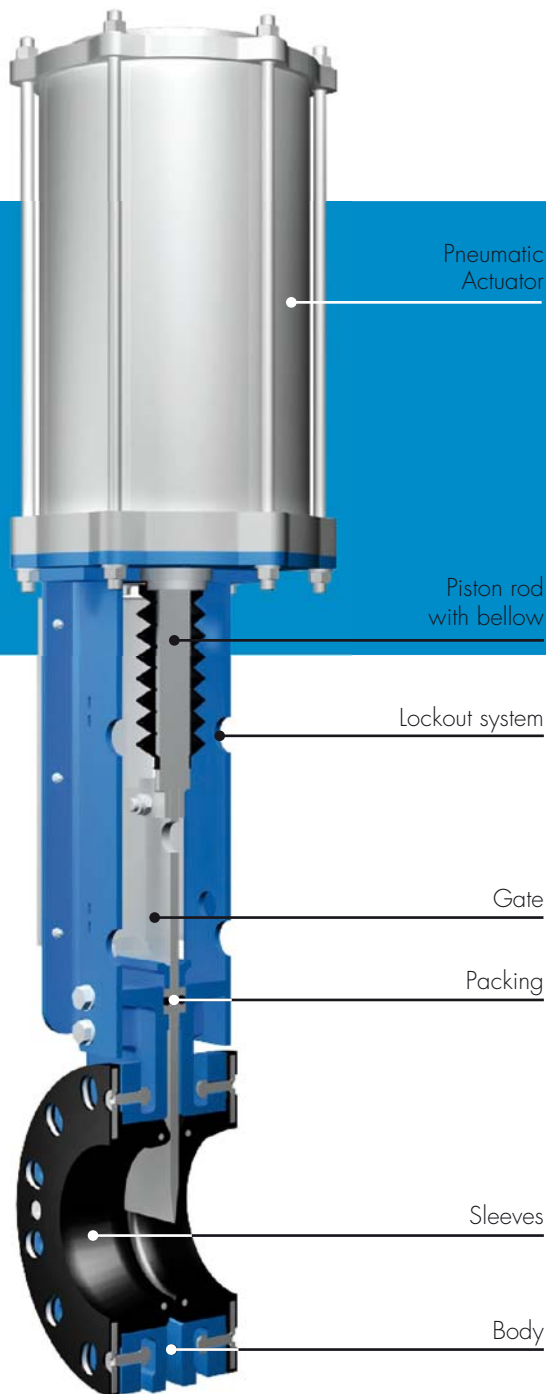

BI-DIRECTIONAL DOUBLE SLEEVE DESIGN



Open position



Closed position

- Gaskets for valve installation not required
- Maintenance free EPDM gland packing for WG. PTFE compression packing plus O-ring for HG, also available for WG
- Stainless steel stem
- Reinforced yoke design
- Optional gate lockout system available
- Epoxy coating on all cast iron and carbon steel components
- Extensions and floor stands
- Automated valves with gate guards in accordance with safety standards
- Wide variety of accessories available: limit & proximity switches, mechanical stops, solenoid valves, manual overrides and fail safe systems
- Splash guards, flat plate and tubular design available



Flat Plate

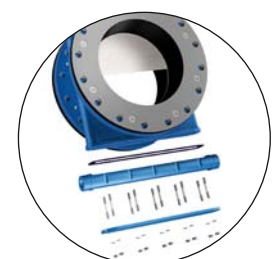

Tubular Design



ORBINOX

VALVE SOLUTIONS IN MORE THAN 70 COUNTRIES

MEMBER OF THE  GROUP

ORBINOX VALVES INTERNATIONAL

Parque Tecnológico de San Sebastián
P^o Mikeletegui, 56-planta 3^o
20009 DONOSTIA-SAN SEBASTIAN, SPAIN
Tel.: + 34 943 69 80 30
Fax: + 34 943 30 92 83
e-mail: ovi@orbinox.com

EUROPE

ORBINOX S.A.

ANOETA, GIPUZKOA • SPAIN
orbinox@orbinox.com

ORBINOX UK

BOGNOR REGIS, WEST SUSSEX • UK
uk@orbinox.com

ORBINOX COMERCIAL

BELAUNTZA, GIPUZKOA • SPAIN
comercial@orbinox.com

ORBINOX GERMANY

SCHWERTE, NRW • GERMANY
germany@orbinox.com

ORBINOX FRANCE

GENAS, REGION LYONNAISE • FRANCE
france@orbinox.com

DAMPER TECHNOLOGY LTD

EASTWOOD, NOTTINGHAM • UK
sales@dampertechnology.com

ASIA

ORBINOX INDIA

COIMBATORE, TAMIL NADU • INDIA
india@orbinox.com

ORBINOX CHINA

BEIJING / SHANGHAI • CHINA
china.sales@orbinox.com

ORBINOX S.E.A.

JAKARTA • INDONESIA
orbinox.sea@orbinox.com

AMERICA

ORBINOX CANADA

LAVAL, QUEBEC • CANADA
canada@orbinox.com

ORBINOX USA

AMORY, MISSISSIPPI • USA
usa@orbinox.com

ORBINOX BRAZIL

INDAIATUBA, SÃO PAULO • BRAZIL
brasil@orbinox.com

ORBINOX CHILE

SANTIAGO • CHILE
chile@orbinox.com

ORBINOX PERU

LIMA • PERU
peru@orbinox.com

www.orbinox.com

